**User's
Manual**

**100 MS/s Digital Oscilloscope Module
WE7111**

**IM 707111-01E
3rd Edition**

Thank you for purchasing the 100 MS/s Digital Oscilloscope Module WE7111 for the PC-based measurement instruments, WE7000.

This User's Manual contains useful information about the function, connection to the measuring station, and troubleshooting of the WE7111. This manual assumes that you will be using the WE7000 Control Software that is included with the measuring station.

For general information about the WE7000 (primarily the operations of the measuring station, the optical interface module, the optical interface card, and the WE7000 Control Software) see the following manual that is included with the measuring station.

Manual Title	Manual No.
WE7000 User's Manual	IM707001-01E

To ensure correct use, please read this manual thoroughly before operation. Keep this manual in a safe place for quick reference in the event a question arises.

Notes

- **The contents of this manual describe WE7000 Control Software Ver. 4.0.2.0 and module software Ver 3.07. If you are using another version of the software, the operating procedures or the figures given in this manual may differ from the actual software.**
- The contents of this manual are subject to change without prior notice as a result of continuing improvements to the instrument's performance and functions.
- Every effort has been made in the preparation of this manual to ensure the accuracy of its contents. However, should you have any questions or find any errors, please contact your nearest YOKOGAWA dealer.
- Copying or reproducing any or all of the contents of this manual without YOKOGAWA's permission is strictly prohibited.

Trademarks

- Microsoft, Windows, and Windows NT are either registered trademarks or trademarks of Microsoft Corporation in the United States and/or other countries.
- Adobe and Acrobat are trademarks of Adobe Systems Incorporated.
- Other product names are trademarks or registered trademarks of their respective holders.

Revisions

1st Edition: December 1998

2nd Edition: July 1999

3rd Edition: August 2000

Checking the Contents of the Package

Unpack the box and check the contents before operating the instrument. If the contents are not correct or missing or if there is physical damage, contact the dealer from which you purchased them.

Measurement Module

Check that the model name given on the name plate match those on the order.

MODEL

Model	Suffix Code	Description
707111		WE7111 100 MS/s Digital Oscilloscope Module
	/HE	English help message

NO.

When contacting the dealer from which you purchased the instrument, please quote the instrument No.

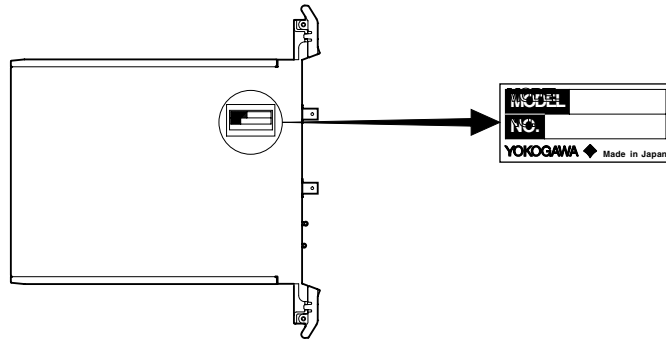

Standard Accessories

The following standard accessories are supplied with the instrument. Make sure that all items are present and undamaged.

User's Manual (1)
IM707111-01E

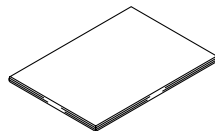

Optional Accessories (sold separately)

Name	Model	Description
150 MHz passive probe	700998	Input resistance: 10 M Ω , Overall length: 1.5 m
Mini clip Converter	B9852CR	
BNC adapter	B9852CS	
Earth lead	B9852CT	
50 Ω terminator	700976	

How to Use This Manual

Structure of the Manual

This User's Manual consists of the following four chapters and an index.

Chapter	Title	Description
1	Explanation of Functions	Explains system configuration and functions.
2	Hardware Preparation	Explains how to install the module into the measuring station and how to connect the input.
3	Troubleshooting and Maintenance	Explains procedures for troubleshooting and self testing.
4	Specifications	Explains the specifications of the module.
Index		Index of contents.

Conventions Used in This Manual

Unit

k Denotes 1000. Example: 100kHz

K Denotes 1024. Example: 720KB

Displayed characters

Alphanumeric characters enclosed with [] usually refer to characters or settings that are displayed on the screen.

Symbols

The following symbol marks are used to attract the operator's attention.



Affixed to the instrument. Indicates danger to personnel or to the instrument. The operator must refer to the User's Manual. The symbol is used in the User's Manual to indicate the reference.

WARNING

Describes precautions that should be observed to prevent injury or death to the user.

CAUTION

Describes precautions that should be observed to prevent minor or moderate injury, or damage to the instrument.

Note

Provides information that is important for operating the instrument properly.

Contents

Checking the Contents of the Package	2
How to Use This Manual	3
Chapter 1 Explanation of Functions	
1.1 System Configuration and Block Diagram	1-1
1.2 Operation Panel	1-2
△ 1.3 Starting/Stopping the Waveform Acquisition and Setting the Vertical Axis/Horizontal Axis	1-4
1.4 Setting the Trigger	1-7
1.5 Setting the Conditions on Acquiring a Waveform	1-9
1.6 Other Settings/Calibration	1-10
1.7 Automatic Saving of the Waveform Data/File Conversion	1-11
1.8 Synchronizing to Other Modules Using the Bus Trigger/Time Base Signal	1-12
1.9 Names and Functions of Sections	1-13
Chapter 2 Hardware Preparation	
△ 2.1 Installing the Module into the Measuring Station	2-1
△ 2.2 Connecting the Input Cable	2-3
△ 2.3 Calibrating Probes (Phase Compensation)	2-4
Chapter 3 Troubleshooting and Maintenance	
3.1 Troubleshooting	3-1
3.2 Self Test	3-2
3.3 Maintenance	3-3
Chapter 4 Specifications	
4.1 Specifications of the Measurement Input Section	4-1
4.2 Specifications of the Trigger Section	4-2
4.3 Specifications of the Time Axis	4-3
4.4 Functional Specification	4-4
4.5 Setting the Time Axis/Sampling Rate/Relationship of the Record Length of the Display Data	4-5
4.6 Default Values (Factory Default Settings)	4-7
4.7 General Specifications	4-8
4.8 Dimensional Drawings	4-10
Index	Index-1

1.1 System Configuration and Block Diagram

System Configuration

The following is an example in which the 100 MS/s Digital Oscilloscope Module WE7111 is installed into the measuring station and the measuring station is connected to the PC with the optical fiber cable.

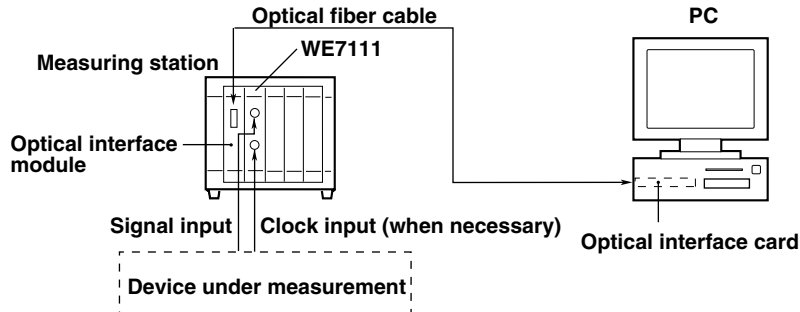

Block Diagram

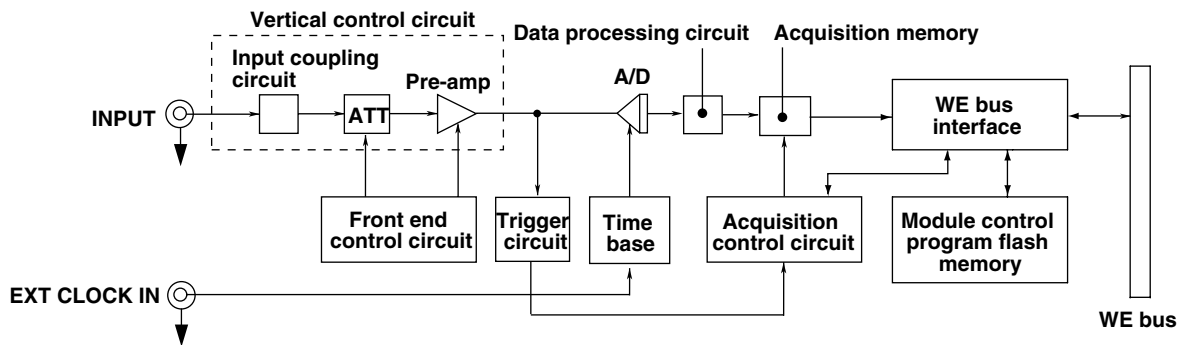

First, the signal applied to the input terminal enters the vertical control circuit. The vertical control circuit consists of the input coupling circuit, attenuator (ATT), and pre-amplifier. The voltage and amplitude of the signal is adjusted according to the input coupling, probe attenuation, vertical sensitivity, and offset voltage settings. Then, the input signal is output to the A/D converter. At the A/D converter, the input signal is sampled by synchronizing to the clock provided by the time base, and converted to digital data. The module samples the input signal at the maximum rate of 100 MS/s which allows measurement of signals with bandwidths up to 40 MHz.

The digital data are processed according to the acquisition mode setting in the data processing circuit and written to the acquisition memory at the sampling rate corresponding to the time axis setting. The data stored in the acquisition memory according to the trigger setting, are output to the WE bus of the measuring station according to the instructions from the PC. Then, the data on the WE bus are transmitted to the PC from the optical interface module through the optical fiber cable or through the serial interface.

1.2 Operation Panel

The WE7000 Control Software that is installed in the PC is used to control the 100 MS/s Digital Oscilloscope Module WE7111. The WE7000 Control Software displays operation panels similar to those shown in the figure below. This User's Manual does not explain the operations of the operation panel or waveform monitor. For the operations of these items, see the on-line help that is provided with the WE7000 Control Software.

Starting/Stopping the waveform acquisition and setting the vertical axis/horizontal axis

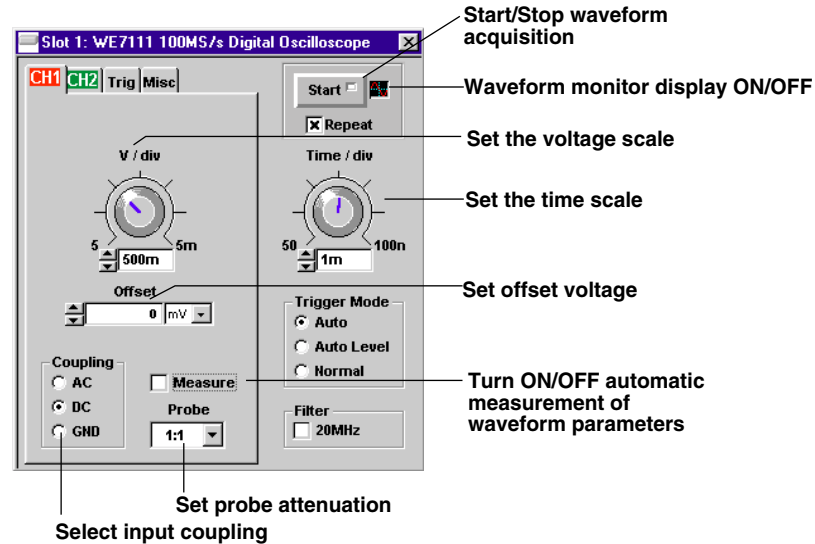

Setting the trigger

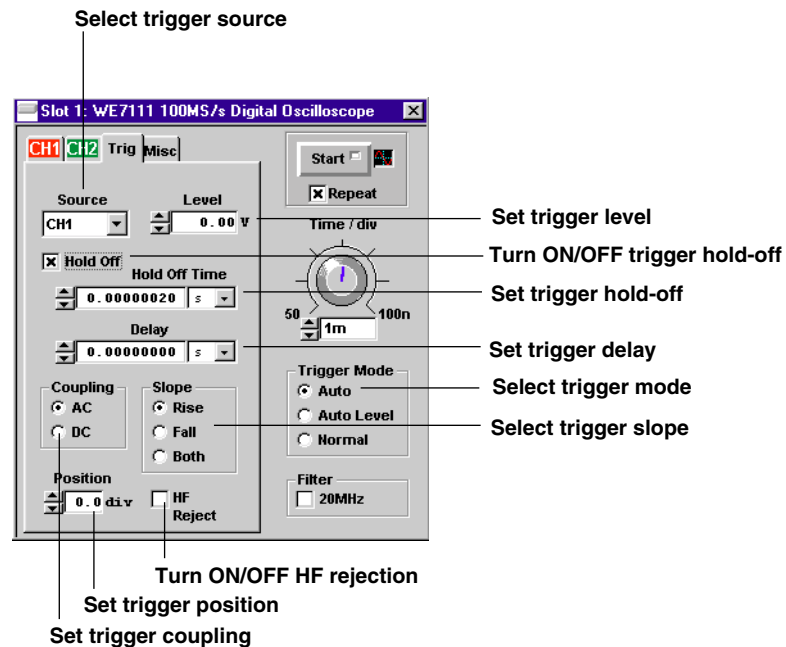

Setting conditions to acquire waveforms and other parameters

The image shows the control panel of a WE7111 Digital Oscilloscope. The panel is divided into several sections with various controls and buttons. Annotations with lines pointing to specific controls provide the following explanations:

- Auto Setup:** A button labeled "Exec" is used to perform auto setup.
- Calibration:** A checkbox labeled "Auto Cal" is used to turn ON/OFF auto calibration. A "Cal Exec" button is also present.
- Acq Mode:** Radio buttons for "Normal", "Envelope", and "Average" are used to select the acquisition mode. The "Average" mode is currently selected.
- Average Count:** A dropdown menu set to "2" is used to set the attenuation constant (available only when averaging mode is selected).
- Time Base:** A dropdown menu set to "Internal" is used to select the time base.
- Record Length:** A dropdown menu set to "10k" is used to set the record length.
- Trigger Mode:** Radio buttons for "Auto", "Auto Level", and "Normal" are used to select the trigger mode.
- Filter:** A checkbox labeled "20MHz" is used to set the input filter.
- Time/div:** A rotary knob is used to adjust the time per division, with a scale showing 50, 100n, and 1m.
- Start/Repeat:** Buttons for "Start" and "Repeat" (with a checked checkbox) are used to initiate and repeat acquisitions.

1.3 Starting/Stopping the Waveform Acquisition and Setting the Vertical Axis/Horizontal Axis

Starting/Stopping Waveform Acquisition

Click the [Start] button. If the [Repeat] check box is selected, the waveform is repeatedly acquired until the [Start] button is pressed again. If it is not checked, acquisition stops the waveform is acquired once. If the record length is set to [100k], the waveform cannot be acquired repeatedly. Thus, the [Repeat] check box does not appear in this case.

Note

To start waveform acquisition using the arming signal, use the trigger source/time base source setting dialog box of the WE7000 Control Software and set the arming. For details on setting the arming signal, see section 4.6, "Setting Trigger Source/Time Base Source/Arming" in the WE7000 User's Manual.

Input Coupling

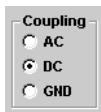

If you wish to observe just the amplitude of an AC signal, or a signal relative to a given reference voltage, it is best to remove the DC component from the input signal. On the other hand, there are times when you wish to check the ground level or observe a signal by removing the offset voltage. Depending on the desired measurement, you can change the input coupling setting that determines how the input signal is input to the vertical control circuit (voltage axis). Select from the following types of input coupling.

AC

The input signal is coupled to the attenuator of the vertical control circuit through a capacitor. Use this setting if you wish to observe just the amplitude of an AC signal, or a signal relative to a given reference voltage.

DC

The input signal is directly coupled to the vertical control circuit. Use this setting if you wish to observe the entire input signal (DC component and AC component). This setting also allows you to observe the waveform by removing unneeded offset voltage (DC voltage) from the input signal. This function is useful in observing the ripple on a DC output signal.

GND

Input signal is coupled to the ground not to the attenuator of the vertical control circuit. This setting allows you to check the ground level on the waveform monitor.

The frequency characteristics of the analog section (vertical control circuit) when the input coupling is set to [AC] or [DC] is as follows.

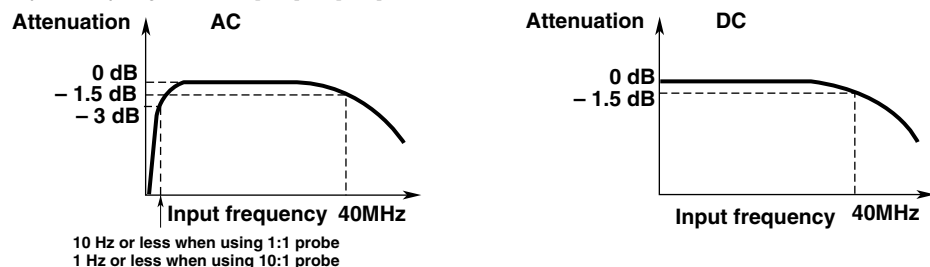

CAUTION

- If the input coupling is AC and the frequency of the input signal is less than 1 Hz, the signal at the input terminal of the module is not attenuated to 1/10 even if the probe with 10:1 attenuation and input resistance of 10 M Ω is used. Therefore, be careful not to apply a voltage with a signal component less than 1 Hz exceeding 250 V (DC + ACpeak) or 177 Vrms to the tip of the probe.

Offset Voltage

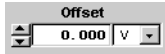

If the input coupling is set to “DC,” you can cancel the specified offset voltage from the input signal. The ranges shown below are values when the probe attenuation is set to “10:1.” If the probe attenuation is 1:1 multiply these values by 1/10. If it is 100:1 multiply by 10. If it is 1000:1 multiply by 100.

Voltage Sensitivity	Selectable Range	Resolution
5 mV to 500 mV/div	-10 V to +10 V	1 mV
1 V to 5 V/div	-100 V to +100 V	10 mV

Probe Attenuation



Normally a probe is used in connecting the circuit being measured to the measurement input terminal. Using the probe has the following advantages.

- Does not disturb the voltage and current of the circuit being measured.
- Inputs the signal with no distortion.
- Expands the voltage range that can be measured by the oscilloscope.

When using the probe, attenuation setting on the module must be set equal to the probe attenuation so that the measured voltage can be read directly.

This module has the following attenuation settings: 1:1, 10:1, 100:1, and 1000:1.

Vertical Sensitivity

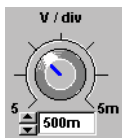

The vertical sensitivity setting is used to adjust the displayed amplitude of the waveform so that it can be easily observed. The vertical sensitivity is set by assigning a voltage value to one grid square (1 div) on the waveform monitor. The value of the vertical sensitivity setting is multiplied by the probe attenuation (as explained above) and displayed.

The vertical sensitivity changes by switching the attenuator to different values of attenuation. It is changed in steps as given by “1 V/div, 2 V/div, and 5 V/div” and set within the range from 5 mV/div to 5 V/div (when the probe attenuation is 1:1).

Time Axis Scale

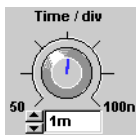

At the initial setting, the sampling timing of waveform data is controlled by the clock signal generated from the time base circuit within the module.

When using this internal clock, the time axis is set in terms of the time per one grid square (1 div) on the waveform monitor. The range is from “100 ns/div to 50 s/div.” The time span displayed on the waveform monitor is calculated by “time axis setting × 10,” because the time axis displays 10 div.

Note

- This setting is void if the time base is set to anything other than [Internal].
- The sampling rate and the record length displayed on the waveform monitor (display record length) change according to the time axis setting. For the relationship between the time axis setting and display record length, see section 4.5, “Setting Time Axis/Sampling Rate/Relationship of Record length of display data.”

Setting the time base to a signal other than the internal clock

Set the time base in the [Time Base] list box of the Misc operation panel displayed by clicking the [Misc] tab of the operation panel. For information on the settings, see the next page. For the procedure for inputting the external clock, see page 2-3.

Selecting the Time Base



Time axis can be controlled not only by the clock signal generated within the module, but also by clock signals from external sources or by signals generated by other modules.

External clock signals are input through the external clock input terminal on the module panel. This external clock input is useful for observing a signal whose period varies or for observing waveforms by synchronizing to the clock signal of the signal being measured.

You can set the time base at the "MISC" operation panel.

- Internal: Internal clock
- EXT CLOCK IN: Input signal through "EXT CLOCK IN" on the module's front panel.
- BUSCLK: Input signal (CMNCLK) according to the trigger source/time base source setting (see section 4.6, "Setting the Trigger Source/Time Base Source/Arming" in the WE7000 User's Manual (IM707001-01E)).

1.4 Setting the Trigger

Trigger Source

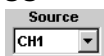

Selects the signal for triggering. Select from the following choices.

CHx: Input signal (includes input signal of linked digital oscilloscope modules)

Line: Commercial power supply signal

BUSTRG: Bus trigger on WE bus (BUSTRG1/BUSTRG2) signal (see section 4.6, "Setting Trigger Source/Time Base Source/Arming" in the WE7000 User's Manual (IM707001-01E))

Trigger Type and Trigger Slope



Edge is the only trigger type available. The trigger is generated when the trigger source goes above the specified trigger level (rising edge) or below the specified level (falling edge)*. Rising or falling is set with the trigger slope. Select from the following choices.

Rise: Rising edge

Fall: Falling edge

Both: Both rising and falling edges

* Trigger refers to the condition in which the trigger condition is satisfied and the waveform is displayed.

Trigger Level



Sets the voltage level for judging the trigger slope (rise/fall of a signal). The setting range is the voltage range corresponding to ± 10 div on the vertical scale. The resolution is 1/50 divisions.

Trigger Mode

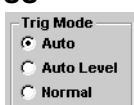

Sets the conditions to update the displayed waveform. There are three types of trigger modes.

Auto mode (Auto)

If a trigger occurs within a specified amount of time (approx. 100 ms, referred to as the timeout period), the waveform display is updated. If the trigger does not occur within the timeout period, the waveform display is automatically updated.

Auto level mode (Auto Level)

If a trigger occurs within the timeout period, the waveform is displayed in the same way as in the auto mode. If a trigger does not occur within the timeout period, the center value of the amplitude of the trigger source is detected, trigger level is automatically changed to the center value, and the trigger is generated to update the displayed waveform.

Normal mode (Normal)

The waveform display is updated only when the trigger occurs.

Trigger Coupling



When you select "measurement input signal" as the trigger source, you can select the input coupling of the signal that will be used as the trigger. Select the input coupling most suitable for the trigger source signal. The following two types of input coupling are available for the trigger source signal.

DC

Select this setting when using the source as is with no processing of the signal.

AC

Select this setting when using a trigger source that has no DC component. A trigger can always be activated if the trigger level is set to 0 V as long as the signal's amplitude is at least one division.

HF Rejection



Turn this ON when you select “measurement input signal” as the trigger source and you wish to remove high frequency components above 15 kHz from the signal before trigger detection. This prevents the trigger from occurring unexpectedly due to high frequency noise.

Trigger Position



The trigger position specifies the position in the waveform, acquired in the acquisition memory, that denotes the point at which the trigger occurred. The point at which the trigger occurred is called the trigger point. If the trigger delay (explained in the next section) is set to 0 s, the trigger point and trigger position match. When the trigger position is 0 div, the trigger position is at the center of the acquired waveform's time axis. In this case, you can observe the waveform before the trigger point. This is possible because sampling data are constantly acquired to the acquisition memory once the waveform acquisition is started (the newest data continuously overwrites the oldest data). When the trigger occurs, the data in the memory are retained and displayed on the waveform monitor. The range is ± 5.0 div, and the resolution is 0.1 div.

Trigger Delay



Normally, the waveform around the trigger point is displayed. However, by using this function, you can display the waveform that is acquired the specified amount of time after the trigger point.

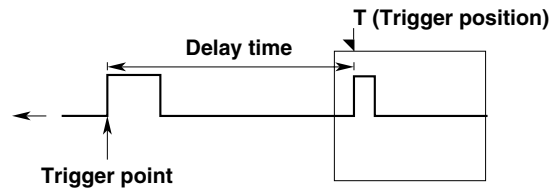

The range is from 0 to 9.9999999 s, and the resolution is 10 ns. Select [us] (microsecond), [ms], or [s] for the unit.

Trigger Hold Off

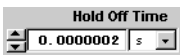

The trigger hold off is used to temporarily stop the detection of the next trigger once a trigger occurs. This function is useful when observing a pulse train signal such as a PCM code by repeatedly adjusting to the period of the signal or when you wish to change the acquisition interval of the waveform.

Check [Hold Off] to execute the trigger hold off and enter a value in the [Hold Off Time] entry box. The range is from 200 ns to 9.9999999 s, and the resolution is 10 ns. Select [us] (microsecond), [ms], or [s] for the unit.

1.5 Setting the Conditions on Acquiring a Waveform

Acquisition Mode

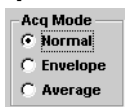

When acquiring sampled data in the acquisition memory, it is possible to process the data beforehand and display the waveform based on the data. The following three data processing methods are available.

Normal mode

In this mode, sampled data are acquired in the acquisition memory without any kind of processing.

Envelope mode

In normal mode and average mode, the sampling rate (the number of data points acquired per second in the acquisition memory) drops if the time per one division is made longer as defined in the time axis setting. In the envelope mode, the maximum and minimum values of the data sampled at 100 MS/s are placed into the acquisition memory at rate equal to the sampling rate for the normal mode. (one pair uses two words of memory). The envelope mode is useful when you want to avoid aliasing, since the sampling rate is kept high irrespective of the time axis setting. It is also useful if you want to detect glitches (pulsing signal that rises very fast) or display the envelope of a modulating signal.

Average mode

Averaging is a process in which waveforms are acquired repeatedly to determine the average of the waveform data at the same time point (the same time in relation to the trigger point). The waveform data are averaged exponentially, and the resulting data are acquired to the acquisition memory and displayed. The attenuation constant can be set between 2 and 256 (in steps of 2^n).

Exponential averaging

$$A_n = \frac{1}{N} \{(N-1)A_{n-1} + X_n\}$$

A_n : Average value on nth time

X_n : Measured value on nth time

N : Attenuation constant

This averaging process is useful for eliminating random noise.

Record Length



The term “record length” refers to the number of data points acquired in the acquisition memory. You can select from [1k], [5k], [10k], [30k], and [100k]*. However, [100k] word cannot be selected if the acquisition mode is set to averaging mode.

Setting a long record length is useful in observing signals with long periods or a fast one-shot signal that lasts a long time.

* If you select 100 kword, the actual record length that is acquired is 120 kword.

Note

- The record length displayed on the waveform monitor (display record length) changes according to the time axis setting. For the relationship between the time axis setting and the display record length, see section 4.5, “Setting Time Axis/Sampling Rate/Relationship of the Record Length and the Display Data.”
- Waveforms cannot be repetitively acquired, if you select [100k] word. The [Repeat] check box does not appear under the [Start] button in this case.

Input Filter



Bandwidth limit

If you select the check box, high frequency noise of 20 MHz or higher can be eliminated from the input signal.

1.6 Other Settings/Calibration

Auto Setup



This function automatically sets the vertical sensitivity, time axis, and trigger settings to suit the signal being measured. This is useful when the characteristics of the signal being measured are unknown. However, this function does not work for all measurement signals.

Input conditions for auto setup

Frequency: Approx. 40 Hz to 40 MHz

Amplitude: Approx. 50 mV or more (when probe attenuation setting is 1:1)

Type: Repetitive waveform (repetition of the waveform cannot be complex)

Setup data after executing auto setup

- Settings related to the vertical axis
 - Voltage sensitivity: Set so that the positive or negative peak voltage falls within 4 div
 - Waveform display position: Same as before
 - Input coupling: DC
 - Offset: 0V
 - Probe attenuation: Same as before
- Settings related to the horizontal axis
 - Time/div: Set so that two to four periods of the input signal with the longest period can be observed. If the input signals of all channels do not meet the above condition, it is set to 1 ms/div.
 - Time base: Internal
- Settings related to trigger
 - Mode: Auto
 - Slope: Rise
 - Coupling: DC
 - Position: 0 div
 - Delay: 0 s
 - Hold Off: OFF
- Settings related to the acquisition conditions of waveforms
 - Acq Mode: Normal
 - Record Length: Same as before
 - Filter: None

Calibration

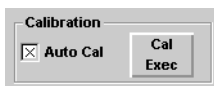

The following parameters are calibrated.

- Ground level offset
- Gain of the A/D converter
- Threshold level of the trigger

Auto calibration function [Auto Cal]

Calibration is automatically executed three minutes, 10 minutes and 30 minutes after the power is turned ON and every 30 minutes there after. It is also performed the first time the time axis setting (Time/div) is changed after the aforementioned time has elapsed.

ON/OFF of Automated Measurement of Waveform Parameters



Waveform parameter values that are measured automatically can be displayed on the waveform monitor. Click the check box when performing automated measurement of waveform parameters. Activating automated measurements on multiple channels may lower the performance of the waveform measurement. Therefore, remove the check if automated measurement is not needed.

1.7 Automatic Saving of the Waveform Data/File Conversion

The following functions are functions of the WE7000 Control Software. For the operations of the following functions, see the on-line help that is provided with the WE7000 control Software.

Automatic Saving of Waveform Data

Besides saving the data displayed on the waveform monitor, you can also have the waveform data automatically saved using a trigger.

There are two methods of saving the data.

Cyclic

You specify the number of files and the data are saved in a cyclic pattern within the specified number of files until the measurement is stopped. The newest data is not the file with the largest file number, but the file to which the data was saved immediately before stopping the measurement.

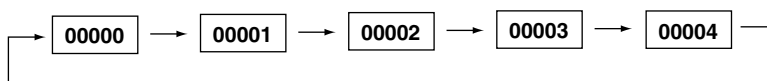

File number limit

You specify the number of files and the data are saved up to the specified number and then the operation stops.

Converting the File Format

Waveform data that are saved can be converted to ASCII data in CSV format (*.csv) or to a physical value in 32-bit floating point format (conforming to IEEE754-1985) (*.wvf). This file conversion can also be performed on data that are saved with the waveform monitor.

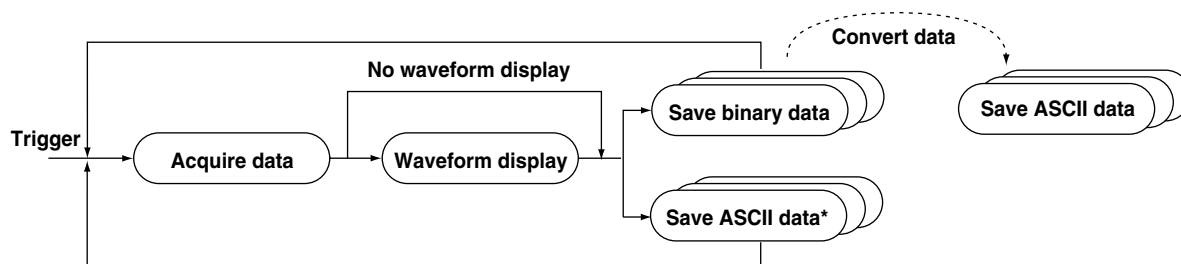

1.8 Synchronizing to Other Modules Using the Bus Trigger/Time Base Signal

Input/Output of Bus Trigger Signals

The trigger signal detected within the 100 MS/s Digital Oscilloscope Module WE7111 can be output to the two trigger signal buses (BUSTRG1/BUSTRG2) in the measuring station. Conversely, the bus trigger signals on the bus can be passed in to trigger the module.

To output the trigger signal detected within the WE7111 to the bus, you must set the trigger source to the input signal or the commercial power supply signal (see 1.4, "Setting the Trigger").

The time delay for the bus trigger signal to be output after the trigger is detected within the module is approximately 100 ns (typical value*). The module outputs "True" to the bus from the time it detects the trigger to the time it finishes acquiring the data. In other words, the time duration in which the module outputs "True" is the duration in which the module acquires the data after the trigger.

To trigger the WE7111 by using the bus trigger signal, set the trigger source to "BUSTRG" and set the WE7111 to input the bus trigger signal in the trigger source/time base source setting dialog box (see 4.6, "Setting the Trigger Source/Time Base Source/Arming" in the WE7000 User's Manual, IM707001-01E). The WE7111 is triggered when the bus trigger signal changes from "False" to "True." The maximum time delay from the time the bus trigger signal changes to the time the WE7111 is actually triggered is given by 30 ns + the sampling period of the WE7111 (typical value*).

* Typical values represents typical or average values. They are not strictly guaranteed.

Input of Time Base Signal

The WE7111 can perform sampling by synchronizing to the time base signal in the measuring station. However, the time base signal must constantly be generated in this case.

If the WE7111 is operating under the clock signal that is passed in from the external clock input terminal [EXT CLOCK IN], the clock signal can be output to the trigger signal bus in the measuring station. If the WE7111 is using an internal clock signal, the signal is not output to the bus.

When outputting the clock signal to the trigger signal bus in the measuring station, set the frequency of the external clock to 10 MHz or less.

Controlling the Timing of the Start of the Measurement (Arming)

When the arming signal (ARM) bus is connected to the measurement module as determined in the trigger source/time base source setting dialog box, the module enters the arming signal wait state when the [Start] button on the module's operation panel is clicked. The measurement starts when the arming signal becomes [True].

If [Repeat] of the [Start] button is checked, the module enters the arming signal wait state after each measurement. When the arming signal becomes [True] again, the module acquires the next waveform.

1.9 Names and Functions of Sections

Front Panel

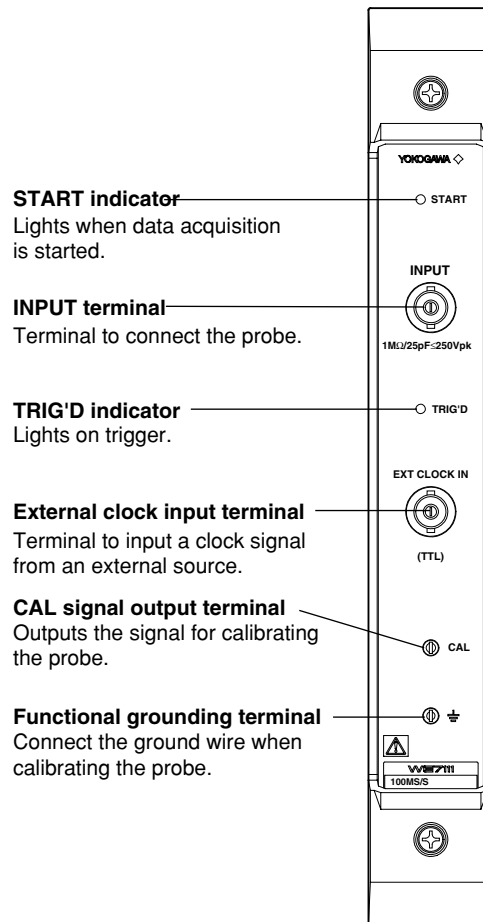

2.1 Installing the Module into the Measuring Station

Preparing to Install the Module

Upon purchasing the measuring station, each slot is covered with a cover plate as shown in the figure below. Verify that the power supply is not connected to the measuring station, then loosen the module attachment screws (2 locations) and remove the cover plate from the slot where the module is going to be installed. Please note that the slot on the left end is dedicated to the communication interface module and therefore this module cannot be installed there.

* The following figure shows an example of the measuring station WE400.

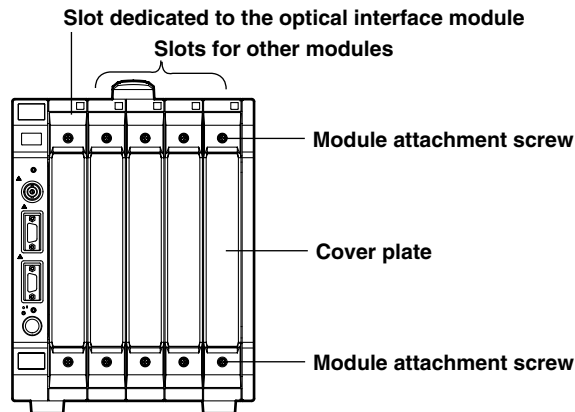

Installing the Digital Oscilloscope Module



WARNING

- Make sure to fasten the top and bottom attachment screws. If you connect the input signal cable without fastening the attachment screws, the protective grounding of the measurement module provided by the power cord is compromised and may cause electric shock.



CAUTION

- To avoid damaging the instrument when installing modules, make sure to turn OFF the standby power switch of the measuring station.
- Be careful not to get your fingers caught in the ejection lever when inserting the module. In addition, do not put your hand inside the slot, because there are protrusions along the module guide that may injure your fingers.
- Do not remove the cover plates from unused slots. It can cause overheating and malfunction. The cover plates are also needed to minimize the influence of electromagnetic interference.

Insert the module along the guide rail of the slot from which you removed the cover plate. Insert the module until it clicks into the connector. Be careful not to get your fingers caught in the ejection lever while inserting the module.

When the module is securely inserted, fasten the module attachment screws (tightening torque: 0.6 to 0.7 N·m).

To remove the module, loosen the module attachment screws, and pull the ejection lever from inside to the outside. This will force the module out of the slot.

<An illustration is shown on the next page.>

2.1 Installing the Module into the Measuring Station

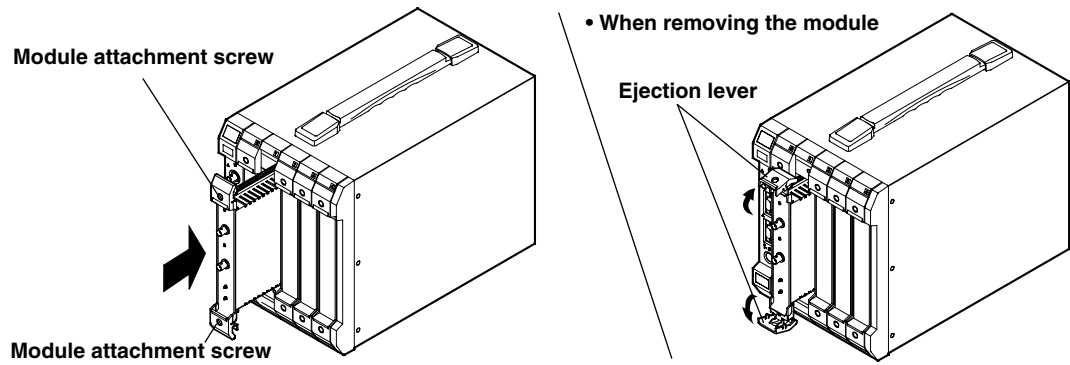

Note

When synchronizing multiple input signals for making measurements, install the multiple digital oscilloscope modules in adjacent slots.

2.2 Connecting the Input Cable

Connecting the Probe



Connect the probe (or other measurement input cables such as a BNC cable) to the input terminal on the front panel of the module (BNC terminal indicated as INPUT). Input impedance is $1\text{ M}\Omega \pm 1.5\%$, and approx. 25 pF .



CAUTION

- The maximum input voltage is 250 V (DC+ACpeak) when the frequency is 1 kHz or below. Applying a voltage exceeding this maximum can damage the input section. When the frequency is above 1 kHz , a voltage less than the maximum voltage can cause damage.

Precautions when Connecting the Probe

- When connecting the probe for the first time, follow the procedures given on the next page, section 2.3, “Calibrating Probes (Phase Compensation)” to perform phase compensation on the probe. If you do not, the probe gain will not be constant across different frequencies, and correct measurements cannot be made. Perform this calibration for each channel.
- Please be aware that, if you directly connect to the circuit under measurement without using the probe, the measurement may not be accurate due to loading effects.

Connecting the External Clock Input Cable



When using a clock signal from an external source to sample the input signal instead of using the internal clock signal, connect the external clock input cable to the external clock input terminal (BNC terminal indicated EXT CLOCK IN) on the front panel of the module.

When operating multiple modules in link, input the external clock to the left most digital oscilloscope module.



CAUTION

- Applying a voltage outside the allowable input voltage range can damage the input section.

The clock signal should conform to the following specifications.

Item	Specification
Allowable input voltage range	-3 to $+8\text{ V}$ (Overvoltage Category CAT I and II)
Input frequency range	40 Hz to 15 MHz (continuous clock only)
Input level	TTL level
Minimum pulse width	25 ns or more for both High and Low
Input format	Non-isolated unbalanced (with $4.7\text{ k}\Omega$ pull-up resistor)

2.3 Calibrating Probes (Phase Compensation)

Necessity of Probe Phase Compensation

If the input capacitance of the probe is not within the suitable range, the gain will not be constant across different frequencies, and the waveform cannot be displayed correctly. The input capacitance of each probe is not constant. Therefore, each probe has a variable capacitor (trimmer) that needs adjusting. This adjustment is called phase compensation.

Make sure to perform phase compensation on probes being used for the first time. Since the suitable input capacitance range varies between modules, phase compensation must also be performed when changing the module to which the probe is connected.

Operating Procedure



CAUTION

- Do not apply external voltage to the CAL signal output terminal. Doing so may damage the input section.

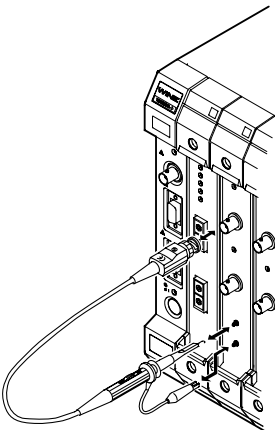

Follow the steps below to perform phase compensation.

1. Turn ON the main power switch and the standby power switch of the measuring station.
2. Connect the probe to the measurement input terminal (terminal which will input the actual measurement signal).
3. Connect the tip of the probe to the CAL output terminal, and connect the ground wire to the functional grounding terminal.
4. Start the WE7000 Control Software and double-click the module icon of the digital oscilloscope module in the station list window to display the operation panel.
5. Click the Misc tab and click the [Exec] button of [Auto Setup] on the displayed operation panel (see section 1.2).
6. Click [Start].

The waveform monitor starts, and the calibration signal is displayed.

7. Insert the tip of a screw driver into the phase adjustment hole of the probe and rotate the variable capacitor until the displayed waveform becomes a proper square wave.

Calibration Signal

The CAL signal output terminal generates the following square wave signal.

Frequency : Approx. 1 kHz

Amplitude : Approx. 1 V

Difference in waveform due to phase compensation of the probe

Correct waveform

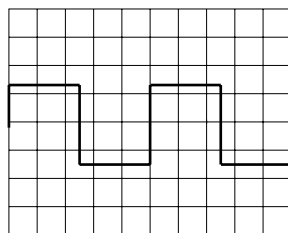

Over-compensated
(Gain in the high frequency region is up)

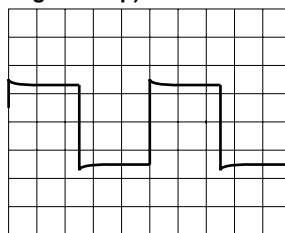

Under-compensated
(Gain in the high frequency region is down)

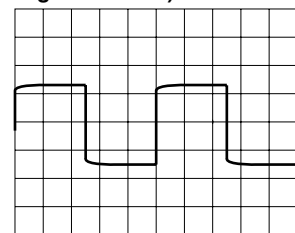

3.1 Troubleshooting

- If servicing is necessary, or if the instrument is not operating correctly after performing the following corrective actions, contact your nearest YOKOGAWA dealer.
- To verify that the module is operating correctly, perform the self test as described on the next page.

Problem	Probable Cause/Corrective Action	Reference
Module does not operate.	Check to see that the module is installed correctly into the station. Also, install the module to another slot, and check whether it will operate there. If it operates in the other slot, the measuring station is likely to have malfunctioned. If the module is installed correctly and does not operate, the connector might be bad or the IC may have malfunctioned. In either case, contact your nearest YOKOGAWA dealer to have it repaired.	2-1, *
Noise enters the input signal	If the signal line and the AC power supply line are close to each other, move them apart. Also make sure that the signal line is away from the noise source. Change to a shielded signal cable if you are not already using one.	2-3
Measured values are not correct.	Check whether the ambient temperature and humidity are within the allowed ranges. If you did not allow a warm-up time of 30 minutes, try measuring again after the warm-up time has passed. Do a calibration. Calibrate the probe. Check the probe attenuation	4-7 1-10 2-4
Trigger does not activate	Verify that the trigger conditions are set properly in the trigger operation panel. If you are using the bus trigger signal, verify that the settings are correct in the trigger source/time base/arming setting dialog box of the WE7000 Control Software.	1-7, 1-8 *
The waveform monitor is not displayed.	Check that the [Waveform monitor ON/OFF] button, that is located to the right of the [Start] button on the operation panel, is turned ON.	1-2
The resultant values of the automated measurement of waveform parameters are not displayed on the waveform monitor.	Check that the [Measure] box on the operation panel is checked.	1-2, 1-10

* See the WE7000 User's Manual (IM 707001-01E).

3.2 Self Test

If you believe that the module is not operating correctly, perform the self test according to the following steps.

Executing self test

1. Connect the probe to the measurement input terminal and connect the tip to the CAL output terminal. Also, connect the ground wire of the probe to the functional grounding terminal.

Use a probe with a “10:1” attenuation. The self test cannot be performed correctly using other probes. Allow a warm-up time of at least 30 minutes, before executing the self test. Otherwise, the self test may not be carried out correctly.

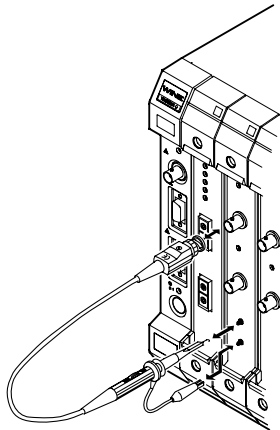

2. Verify that the probe attenuation is set correctly on the operation panel.
3. Select [Self Test] from the [System] menu of the WE7000 Control Software.

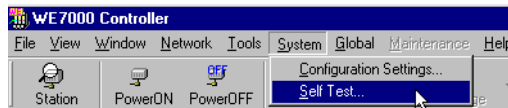

4. In the [Self Test] dialog box that appears, select the station name and enter the slot number corresponding to the module, and click the [Execute] button.

“Executing...” is displayed in the result display box.

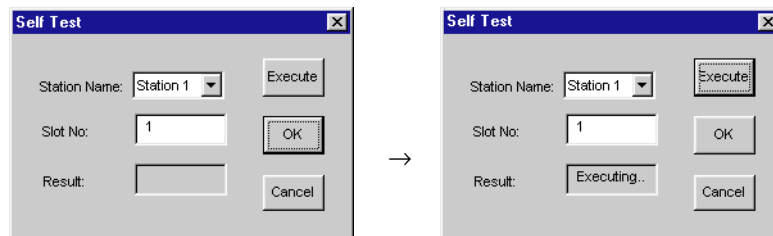

Verifying Test Results

If a value other than “0” is displayed in the “Result” display box of the “Self Test” dialog box, the module is probably malfunctioning. Please contact your nearest YOKOGAWA dealer.

3.3 Maintenance

Maintenance of Parts

There are no parts in this module that require periodic replacement.

Calibration

We recommend that you calibrate the measurement module once a year to assure its measurement accuracy. Please contact your nearest YOKOGAWA dealer to have the module calibrated.

4.1 Specifications of the Measurement Input Section

Number of Input Channels

1

Input Coupling

AC, DC, GND

Connector Type

BNC

Input Impedance

1 M Ω \pm 1.5%, approx. 25 pF

Voltage Sensitivity Range

5 mV/div to 5 V/div (in 1-2-5 steps)

Maximum Input Voltage (When the Frequency Is 1 kHz or Less)

250 V (DC + AC_{peak}) or 177 V_{rms} (Overvoltage Category: CAT I and II)

Maximum DC Offset Range (When Probe Attenuation Is Set to 1:1)

5 mV/div to 50 mV/div: \pm 1 V, 100 mV/div to 500 mV/div: \pm 10 V, 1 V/div to 5 V/div: \pm 100 V

Voltage Accuracy

DC accuracy

At 100 mV/div: \pm (1.5% of 8 div + 1 LSB)At other voltage axis: \pm (2.5% of 8 div + 1 LSB)

Offset voltage accuracy ^{*1}

5 mV/div to 50 mV/div: \pm (2.5% of setting value + 0.2 mV)100 mV/div to 500 mV/div: \pm (1% of setting value + 2 mV)1 V/div to 5 V/div: \pm (2.5% of setting value + 20 mV)

Frequency Characteristics^{*1} (When a Sine Wave with an Amplitude Equivalent to \pm 4 Div Is Applied)

DC to 40 MHz (-1.5 dB attenuation point, no bandwidth limiting) (Typical value^{*3})

-3 dB Low Frequency Attenuation Point^{*1} during AC Coupling

10 Hz or less (1 Hz or less when using the separately sold 150 MHz passive probe (Model: 700998))

Skew between Modules (When Operating with Linked Modules)^{*1}

2 ns for each module (Typical value when settings are all the same^{*3})

Residual Noise Level^{*2}

larger of the two \pm 0.7 mV or \pm 0.12 div (Typical value^{*3})

Isolation between Channels (When Voltage Sensitivities Are Same, DC to 40 MHz, Operating with Linked Modules)^{*1}

 -40 dB (Typical value^{*3})

A/D Conversion Resolution

8 bit (25 LSB/div)

Probe Attenuation Settings

1:1, 10:1, 100:1, 1000:1

Bandwidth Limiting

20 MHz bandwidth limiting ON/OFF possible

Maximum Sampling Rate

100 MS/s

Maximum Record Length

100 kword

^{*1} Value measured under standard operation after calibration with the time base set to internal.

^{*2} Value when the input section is shorted, record length: 10 kword, acquisition mode: normal mode, accumulate: OFF, probe attenuation: 1:1.

^{*3} Typical value represents typical or average value. It is not strictly guaranteed.

4.2 Specifications of the Trigger Section

Trigger Source

Input signal (includes input signal from linked digital oscilloscope modules), commercial power source signal, Bus trigger (BUSTRG1/BUSTRG2) signal of WE bus

Bus Trigger (BUSTRG1/BUSTRG2) Signal Output Source

Able to output the trigger that is detected when the input signal or commercial power signal is specified for the trigger source.

Trigger Type

Edge trigger

Trigger Mode

Auto

Automatically acquires the waveform if the trigger does not occur for more than approx. 100 ms.

Auto level

If the trigger does not occur for more than approx. 100 ms, the trigger level is automatically set to the center value of the amplitude and the trigger is activated.

Normal

Acquire the waveform only when the trigger occurs.

Trigger Slope

Rising, falling, rising/falling

Trigger Coupling

Select DC or AC when the measurement input signal is selected for the trigger source.

HF Rejection

Enable/disable bandwidth limiting (DC to approx. 15 kHz) on the measurement input signal when the measurement input signal is selected as the trigger source.

Trigger Level ^{*1}

Selectable range

Voltage corresponding to ± 10 div of voltage sensitivity (must be within waveform display frame)

Resolution

1/50 div

Accuracy

$\pm(1 \text{ div} + 10\% \text{ of trigger level})$

Trigger Sensitivity ^{*1*2} (When Frequency of Trigger Source Is DC to 40 MHz)

1 divp-p

Trigger Position

Selectable range: +5.0 div to -5.0 div

Resolution: 0.1 div

Trigger Delay Range

0 to 9.99999999 s

Trigger Hold Off Range

200 ns to 9.99999999 s

^{*1} Value measured under standard operating conditions after calibration with the trigger signal set to a signal with a rate of change within 10 div/ms and amplitude within ± 5 div under the following settings:

Trigger mode: Normal, Trigger level: within $\pm 60\%$ of the amplitude of the trigger signal, HF rejection: OFF

^{*2} Value measured with the voltage sensitivity set to 50 mV/div when a pulse with amplitude 5 divp-p, and rising time of 1 ns is input.

Trigger coupling: DC, HF rejection: OFF

4.3 Specifications of the Time Axis

Time Axis Range

100 ns/div to 50 s/div

Time Axis Accuracy*

$\pm(0.01\%$ of reading + 500 ps)

External Clock Input (EXT CLOCK IN)

Connector type

BNC

Maximum input voltage

-3 to +8 V (Overvoltage Category CAT I and II)

Input frequency range

40 Hz to 15 MHz (continuous clock only)

Input level

TTL level

Minimum pulse width

25 ns or more for both High/Low

Input format

Non-isolated unbalanced (with 4.7 k Ω pull-up resistor)

* Value measured under standard operating conditions after calibration with the time base set to internal.

4.4 Functional Specification

Auto Set-up

Automatically sets voltage axis, time axis, trigger level

Initialize

Reset settings to factory default settings

Calibration

Auto calibration and manual calibration available

Acquisition Mode

Select from normal, envelope, and average

Record Length

1 kword/5 kword/10 kword/30 kword/100 kword (100 kword is not selectable when averaging)

Input Filter

20 MHz bandwidth limiting

Calibration Signal Output

Approx. 1 kHz, approx. 1 Vp-p square wave

4.5 Setting the Time Axis/Sampling Rate/Relationship of the Record Length of the Display Data

The data record length that is displayed on the waveform monitor (displayed record length) varies according to the time axis setting (Time/div) and the acquisition mode as follows.

When Record Length Is 1 k/5 kword

Time/div	Record Length: 1 kW				Record Length: 5 kW			
	Normal/Average		Envelope		Normal/Average		Envelope	
	Sample rate (S/s)	Displayed record length	Sample rate (S/s)	Displayed record length	Sample rate (S/s)	Displayed record length	Sample rate (S/s)	Displayed record length
50 s	2	1 k	2	1 k	10	5 k	10	5 k
20 s	3	1 k	3	1 k	20	4 k	20	4 k
10 s	10	1 k	10	1 k	50	5 k	50	5 k
5 s	20	1 k	20	1 k	100	5 k	100	5 k
2 s	50	1 k	50	1 k	200	4 k	200	4 k
1 s	100	1 k	100	1 k	500	5 k	500	5 k
500 ms	200	1 k	200	1 k	1 k	5 k	1 k	5 k
200 ms	500	1 k	500	1 k	2 k	4 k	2 k	4 k
100 ms	1 k	1 k	1 k	1 k	5 k	5 k	5 k	5 k
50 ms	2 k	1 k	2 k	1 k	10 k	5 k	10 k	5 k
20 ms	5 k	1 k	5 k	1 k	20 k	4 k	20 k	4 k
10 ms	10 k	1 k	10 k	1 k	50 k	5 k	50 k	5 k
5 ms	20 k	1 k	20 k	1 k	100 k	5 k	100 k	5 k
2 ms	50 k	1 k	50 k	1 k	200 k	4 k	200 k	4 k
1 ms	100 k	1 k	100 k	1 k	500 k	5 k	500 k	5 k
500 μs	200 k	1 k	200 k	1 k	1 M	5 k	1 M	5 k
200 μs	500 k	1 k	500 k	1 k	2 M	4 k	2 M	4 k
100 μs	1 M	1 k	1 M	1 k	5 M	5 k	5 M	5 k
50 μs	2 M	1 k	2 M	1 k	10 M	5 k	10 M	5 k
20 μs	5 M	1 k	5 M	1 k	20 M	4 k	10 M	2 k
10 μs	10 M	1 k	10 M	1 k	50 M	5 k	10 M	1 k
5 μs	20 M	1 k	10 M	500	100 M	5 k	Switches to normal mode	
2 μs	50 M	1 k	10 M	200	100 M	2 k		
1 μs	100 M	1 k	Switches to normal mode		100 M	1 k		
500 ns	100 M	500			100 M	500		
200 ns	100 M	200	Switches to normal mode		100 M	200		
100 ns	100 M	100			100 M	100		

When Record Length Is 10 k/30 kword

Time/div	Record Length: 10 kW				Record Length: 30 kW			
	Normal/Average		Envelope		Normal/Average		Envelope	
	Sample rate (S/s)	Displayed record length	Sample rate (S/s)	Displayed record length	Sample rate (S/s)	Displayed record length	Sample rate (S/s)	Displayed record length
50 s	20	10 k	20	10 k	50	25 k	50	25 k
20 s	50	10 k	50	10 k	100	20 k	100	20 k
10 s	100	10 k	100	10 k	200	20 k	200	20 k
5 s	200	10 k	200	10 k	500	25 k	500	25 k
2 s	500	10 k	500	10 k	1 k	20 k	1 k	20 k
1 s	1 k	10 k	1 k	10 k	2 k	20 k	2 k	20 k
500 ms	2 k	10 k	2 k	10 k	5 k	25 k	5 k	25 k
200 ms	5 k	10 k	5 k	10 k	10 k	20 k	10 k	20 k
100 ms	10 k	10 k	10 k	10 k	20 k	20 k	20 k	20 k
50 ms	20 k	10 k	20 k	10 k	50 k	25 k	50 k	25 k
20 ms	50 k	10 k	50 k	10 k	100 k	20 k	100 k	20 k
10 ms	100 k	10 k	100 k	10 k	200 k	20 k	200 k	20 k
5 ms	200 k	10 k	200 k	10 k	500 k	25 k	500 k	25 k
2 ms	500 k	10 k	500 k	10 k	1 M	20 k	1 M	20 k
1 ms	1 M	10 k	1 M	10 k	2 M	20 k	2 M	20 k
500 μs	2 M	10 k	2 M	10 k	5 M	25 k	5 M	25 k
200 μs	5 M	10 k	5 M	10 k	10 M	20 k	10 M	20 k
100 μs	10 M	10 k	10 M	10 k	20 M	20 k	10 M	10 k
50 μs	20 M	10 k	10 M	5 k	50 M	25 k	10 M	5 k
20 μs	50 M	10 k	10 M	2 k	100 M	20 k	Switches to normal mode	
10 μs	100 M	10 k	Switches to normal mode		100 M	10 k		
5 μs	100 M	5 k			100 M	5 k		
2 μs	100 M	2 k	Switches to normal mode		100 M	2 k		
1 μs	100 M	1 k			100 M	1 k		
500 ns	100 M	500	Switches to normal mode		100 M	500		
200 ns	100 M	200			100 M	200		
100 ns	100 M	100	Switches to normal mode		100 M	100		

When Record Length Is 100 kword

Time/div	Record Length: 100 kW (120 kW)*			
	Normal		Envelope	
	Sample rate (S/s)	Displayed record length	Sample rate (S/s)	Displayed record length
50 s	200	100 k	200	100 k
20 s	500	100 k	500	100 k
10 s	1 k	100 k	1 k	100 k
5 s	2 k	100 k	2 k	100 k
2 s	5 k	100 k	5 k	100 k
1 s	10 k	100 k	10 k	100 k
500 ms	20 k	100 k	20 k	100 k
200 ms	50 k	100 k	50 k	100 k
100 ms	100 k	100 k	100 k	100 k
50 ms	200 k	100 k	200 k	100 k
20 ms	500 k	100 k	500 k	100 k
10 ms	1 M	100 k	1 M	100 k
5 ms	2 M	100 k	2 M	100 k
2 ms	5 M	100 k	5 M	100 k
1 ms	10 M	100 k	10 M	100 k
500 μs	20 M	100 k	10 M	50 k
200 μs	50 M	100 k	10 M	20 k
100 μs	100 M	100 k	Switches to normal mode	
50 μs	100 M	50 k		
20 μs	100 M	20 k		
10 μs	100 M	10 k		
5 μs	100 M	5 k		
2 μs	100 M	2 k		
1 μs	100 M	1 k		
500 ns	100 M	500		
200 ns	100 M	200		
100 ns	100 M	100		

* Setting is 100 k word, but 120 k word of data are actually acquired.

4.6 Default Values (Factory Default Settings)

Vertical axis/horizontal axis settings

Coupling (Input coupling): DC
Offset (Offset voltage): 0 V
Probe (Probe attenuation): 1:1
V/div (Time axis): 1 ms
Time Base (Selecting the time base): Internal

Trigger settings

Source (trigger source): CH1
Slope (trigger slope): Rise
Level (trigger level): 0.0 V
Trig Mode (trigger mode): Auto
Coupling (trigger coupling): AC
HF Reject (HF rejection): Off
Position (trigger position): 0.0 div
Delay (trigger delay): 0 s
Hold Off (trigger hold off ON/OFF): Off
Hold Off Time (trigger hold time): 200 ns

Conditions on acquiring a waveform and other settings

Acq Mode (acquisition mode): Normal
Average Count (attenuation constant on the average mode): 2
Record Length: 10 k
Filter 20MHz (frequency bandwidth limiting): Off
Auto Cal(auto calibration): On
Repeat (repeatedly measurement): On

4.7 General Specifications

Safety Standard

Complies with CSA C22.2 No.1010.1 and EN61010-1, conforms to JIS C1010-1.

- Overvoltage category CAT I and II¹
- Pollution degree 1 and 2²

EMC standards

Emission

Complying standard

EN55011 Group 1 Class A

This product is a Class A (for industrial environment) product. Operation of this product in a residential area may cause radio interference in which case the user is required to correct the interference.

Cable requirement

Double shielded coaxial cables (3D-2W BNC cable)

Immunity

Complying standard

EN50082-2

Influence in the immunity environment

Noise increase: $\leq \pm 100$ mV

Testing condition

100 MS/s; 50mV/div; Normal Sampling Mode; Input 3 m double shielded cable with open terminated.

Standard Operating Conditions

Ambient temperature: $23 \pm 2^\circ\text{C}$, Ambient humidity: $50 \pm 10\%$ RH, Error in supply voltage/frequency: within 1% of rating, after warm-up time has passed

Warm-up Time

At least 30 minutes

Operating Conditions

Same as that of the measuring station

Storage Conditions

Temperature: -20 to 60°C

Humidity: 20 to 80% RH (no condensation)

Power Consumption

15 VA (Typical value at 100 V/50 Hz ³)

External Dimensions

Approx. 33 mm(W) × 243 mm(H) × 232mm(D) (projections excluded)

Weight

Approx. 0.9 kg

Number of Used Slots

1

Standard Accessories

User's Manual (1)

Optional Accessories

700998	150 MHz passive probe (Input resistance: 10 M Ω (10:1), length: 1.5 m)
B9852CR	Mini clip converter
B9852CS	BNC adapter
B9852CT	Ground lead
700976	50 Ω terminator

- ^{*1} Overvoltage Categories define transient overvoltage levels, including impulse withstand voltage levels.
- Overvoltage Category I: Applies to equipment supplied with electricity from a circuit containing an overvoltage control device.
- Overvoltage Category II: Applies to equipment supplied with electricity from fixed installations like a distribution board.
- ^{*2} Pollution Degree: Applies to the degree of adhesion of a solid, liquid, or gas which deteriorates withstand voltage or surface resistivity.
- Pollution Degree 1: Applies to closed atmospheres (with no, or only dry, non-conductive pollution).
- Pollution Degree 2: Applies to normal indoor atmospheres (with only non-conductive pollution).
- ^{*3} Typical value represents typical or average value. It is not strictly guaranteed.

4.8 Dimensional Drawings

Unit: mm

100 MS/s Digital Oscilloscope Module (WE7111)

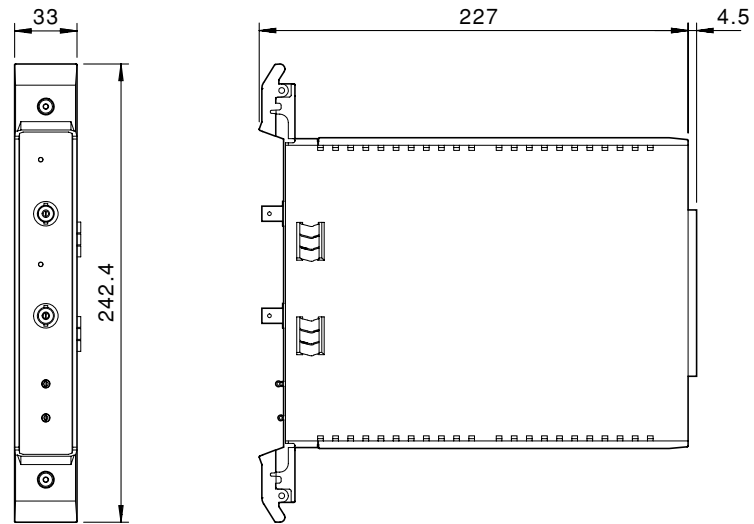

If not specified, the tolerance is $\pm 3\%$. However, in cases of less than 10 mm, the tolerance is ± 0.3 mm.

Index

A

AC 1-4, 1-7
 Acquisition Mode 1-9
 Auto Cal 1-10
 Auto mode 1-7
 Auto Setup 1-10, 2-4
 Auto-level mode 1-7
 Automated measurement of waveform parameters 1-10
 Automatic Saving of Waveform Data 1-11
 Average mode 1-9

B

Both 1-7
 Bus Trigger Signal Input/Output 1-12
 BUSCLK 1-6
 BUSTRG 1-7

C

CAL 1-13, 2-4
 Calibrating Probes 2-4
 Calibration 1-10
 Clock signal 2-3
 Converting File Format 1-11

D

DC 1-4, 1-7

E

Envelope mode 1-9
 EXT CLOCK IN 1-6, 2-3
 External clock input cable, connecting 2-3

F

Fall 1-7
 Functional grounding terminal 1-13

G

GND 1-4

H

HF Rejection 1-8
 Hold Off 1-8

I

INPUT 1-13, 2-3
 Input Coupling 1-4
 Input Filter 1-9
 INPUT terminal 1-13
 Internal 1-6

L

Line 1-7

M

MODEL 2
 Module, installing the 2-1

N

NO 2
 Normal mode 1-7, 1-9

O

Offset Voltage 1-5

P

Package, contents of the 2
 Phase compensation 2-4
 Probe attenuation 1-5
 Probe calibration 2-4
 Probe, connecting the 2-3

R

Record Length 1-9
 Repeat 1-4
 Rise 1-7

S

Start 1-4
 START indicator 1-13

T

Time base, selecting the 1-6
 Time base signal, inputting 1-12
 TRIG'D 1-13
 Trigger Coupling 1-7
 Trigger Delay 1-8
 Trigger Hold-off 1-8
 Trigger Level 1-7
 Trigger Mode 1-7
 Trigger Position 1-8
 Trigger Slope 1-7
 Trigger Source 1-7
 Trigger Type 1-7
 Troubleshooting 3-1

V

Vertical control circuit 1-1
 Vertical sensitivity 1-5

W

Waveform acquisition, starting/stopping 1-4
 WE bus 1-1